

klio 3-353

Studio Hannes Wettstein, 2014

Sitz gepolstert, Rücken und Hinterfüsse massiv gebogen, stapelbar bis zu 3 Stühlen, Reihenverbindung möglich
B54, T51, H76.5, SH46.5

Studio Hannes Wettstein, 2014

Assise rembourrée, dossier et pieds arrière en bois massif cintré, empilable jusqu'à 3 chaises, système d'accouplement en option
L54, P51, H76.5, HAss46.5

Studio Hannes Wettstein, 2014

upholstered seat, back and rear legs of solid bentwood, stackable up to 3 chairs, optional row connector
W54, D51, H76.5, SH46.5

Varianten / variantes / variants



Klio
3-350



Klio
3-350a



Klio
3-353a

Technische Angaben / specifications / specifications

Masse / mesure / measure

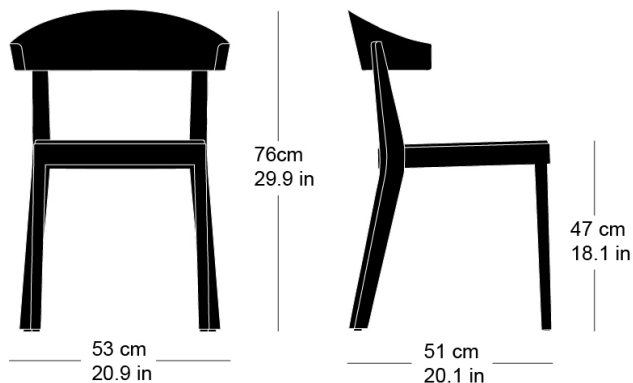

Gewicht / poids / weight	4.8 kg 9.6 lb
Polsterung / rembourrage / upholstery	ja / oui / yes
Reihenverbindung / accouplement / mating system	ja / oui / yes
Stapelung / empilage / stacking	3 Stühle / chaises / chairs

klio 3-353

Holzarten / types de bois / types of wood

Belag / revêtement / surface



Buche natur BN 000 AM
Beech natural BN 000 AM
Hêtre naturel BN 000 AM



Buche schwarz BB 203 SG
Beech black BB 203 SG
Hêtre noir BB 203 SG



Eiche natur EN 000 AM
Oak natural EN 000 AM
Chêne naturel EN 000 AM



Buche anthrazit BB 200 SG
Beech anthracite BB 200 SG
Hêtre anthracite BB 200 SG



Buche geweisst BG 172 SG
Beech whitewashed BG 172 SG
Hêtre teinté blanc BG 172 SG



Eiche Räuchereiche EB 535 AM
Oak smoked oak EB 535 AM
Chêne chêne fumée EB 535 AM



Buche Ebony BB 100 SG
Beech ebony BB 100 SG
Hêtre teinté ebony BB 100 SG



Buche Nuss BB 151 SG
Beech walnut BB 151 SG
Hêtre teinté noyer BB 151 SG