

lounge esprit 6-695a

Hannes Wettstein, 2007

Sessel, Sitz mit Komfortpolsterung, Rücken
Formsperrholz, Polster vorne aufgesetzt, Füsse und
Rückenschwinge massiv gebogen, stapelbar
B59, T63, H75, SH41, ALH61

Hannes Wettstein, 2007

Siège, assise avec rembourrage confort, dossier en
contreplaqué moulé 3D, rembourré à l'avant, dossiers et
pieds en bois massif courbé, empilable
L59, P63, H75, HAss41, HAcc61

Hannes Wettstein, 2007

Chair, seat with comfort upholstery, moulded plywood
back, upholstered on the front, legs and rear cross-brace
solid bentwood, stackable
W59, D63, H75, SH41, ALH61

Varianten / variantes / variants

Lounge
6-693Lounge
6-693aLounge
6-695Lounge
6-675Lounge
6-675a

Technische Angaben / specifications / specifications

Masse / mesure / measure

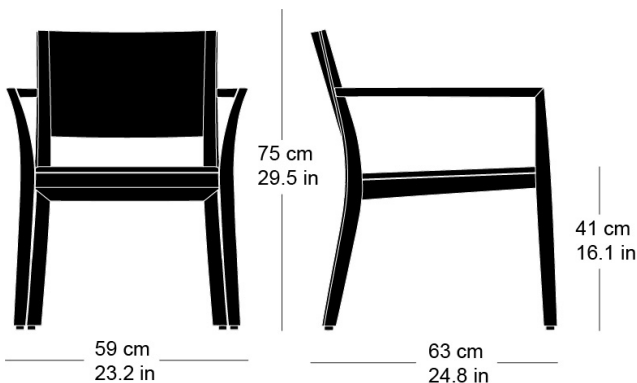

Gewicht / poids / weight 7.2 kg 14.4 lb

Polsterung / rembourrage /
upholstery ja / oui / yes

Stapelung / empilage / stacking 4 Stühle / chaises / chairs

lounge esprit 6-695a

Holzarten / types de bois / types of wood



Buche natur	BN 000 AM
Beech natural	BN 000 AM
Hêtre naturel	BN 000 AM



SchwarznuSS natur	NN 000 AM
Black walnut natural	NN 000 AM
Noyer noir naturel	NN 000 AM



Eiche natur	EN 000 AM
Oak natural	EN 000 AM
Chêne naturel	EN 000 AM



Buche schwarz	BB 203 SG
Beech black	BB 203 SG
Hêtre noir	BB 203 SG



Esche natur	FN 000 AM
Ash natural	FN 000 AM
Frêne naturel	FN 000 AM



Buche anthrazit	BB 200 SG
Beech anthracite	BB 200 SG
Hêtre anthracite	BB 200 SG



Buche geweisst	BG 172 SG
Beech whitewashed	BG 172 SG
Hêtre teinté blanc	BG 172 SG



Eiche Räuchereiche	EB 535 AM
Oak smoked oak	EB 535 AM
Chêne chêne fumée	EB 535 AM



Esche weisspigmentiert	FW 001 OL
Ash white-pigmented	FW 001 OL
Frêne pigmenté blanc	FW 001 OL

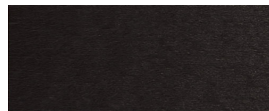

Buche Ebony	BB 100 SG
Beech ebony	BB 100 SG
Hêtre teinté ebony	BB 100 SG

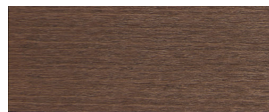

Buche Nuss	BB 151 SG
Beech walnut	BB 151 SG
Hêtre teinté noyer	BB 151 SG

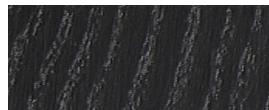

Esche schwarz	FB 203 AM
Ash black	FB 203 AM
Frêne noir	FB 203 AM

Belag / revêtement / surface