

matura mandarin 6-596a



Hannes Wettstein, 2007

Sessel, Sitz gepolstert, Rücken Formsperrholz, Polster vorne aufgesetzt, Füsse und Rückenschwinge massiv gebogen, stapelbar, Reihenverbindung möglich
B59, T57, H82, SH47, ALH67

Hannes Wettstein, 2007

Siège, assise rembourrée, dossier canné, montants de dossier et pieds en bois massif cintré, empilable, système d'accouplement en option
L59, P57, H82, HAss47, HAcc67

Hannes Wettstein, 2007

Armchair, upholstered seat, moulded plywood back, upholstered on the front, legs and rear cross-brace solid bentwood, stackable, optional row connector
W59, D57, H82, SH47, ALH67

Varianten / variantes / variants



Matura
6-590



Matura
6-590a



Matura
6-593



Matura
6-593a



Matura
6-595



Matura
6-595a



Matura
6-596

Technische Angaben / specifications / specifications

Masse / mesure / measure

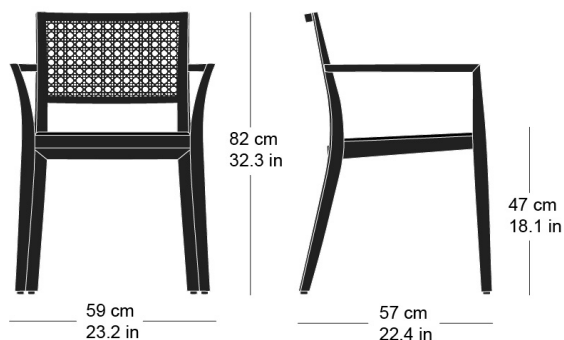

Gewicht / poids / weight 6.0 kg 12.0 lb

Polsterung / rembourrage / upholstery ja / oui / yes

Reihenverbindung / accouplement / mating system ja / oui / yes

Stapelung / empilage / stacking 4 Stühle / chaises / chairs

matura mandarin 6-596a

Holzarten / types de bois / types of wood

Belag / revêtement / surface



Hêtre naturel BN 000 AM
Buche natur BN 000 AM
Beech natural BN 000 AM



Noyer noir naturel NN 000 AM
Schwarznuss natur NN 000 AM
Black walnut natural NN 000 AM



Chêne naturel EN 000 AM
Eiche natur EN 000 AM
Oak natural EN 000 AM



Hêtre noir BB 203 SG
Buche schwarz BB 203 SG
Beech black BB 203 SG



Frêne naturel FN 000 AM
Esche natur FN 000 AM
Ash natural FN 000 AM



Hêtre anthracite BB 200 SG
Buche anthrazit BB 200 SG
Beech anthracite BB 200 SG



Hêtre teinté blanc BG 172 SG
Buche geweisst BG 172 SG
Beech whitewashed BG 172 SG



Hêtre teinté ebony BB 100 SG
Buche Ebony BB 100 SG
Beech ebony BB 100 SG



Frêne pigmenté blanc FW 001 OL
Esche weisspigmentiert FW 001 OL
Ash white-pigmented FW 001 OL



Hêtre teinté noyer BB 151 SG
Buche Nuss BB 151 SG
Beech walnut BB 151 SG



Frêne noir FB 203 AM
Esche schwarz FB 203 AM
Ash black FB 203 AM